

Author Response to Interactive Comment on “Towards a more complete quantification of the global carbon cycle” by Kirschbaum et al.

5 Response to Reviewer #1

Reviewer comment: This is a novel and interesting paper that should stimulate discussion around this important topic. It brings together a quantification of many relatively small elements of the global carbon cycle that when combined could make a substantial reduction in the “residual sink” that has typically been assigned to the terrestrial biosphere. The paper further makes explicit some aspects which had previously been implicit in the budget – as the authors state, this improves clarity. Overall, the implications for vegetation modelling could indeed be substantial as there is an implication that current global vegetation models (which simulate an imbalance within the uncertainty of the residual sink; Le Quéré et al., 2018) may be overestimating the carbon sink provided by the biosphere (but see comment below about how this discussion is presented).

Response: We would like to thank the reviewer for this positive overall assessment. The comment clearly summarises what we had intended to do with this paper.

Reviewer comment: Many of the estimates included have been published elsewhere or are novel contributions but very provisional. This paper will certainly not be the last word on those numbers, however the important thing that this paper does is to bring them all together in a consistent format and set them in the context of the global carbon budget. Careful attention has been paid to whether the fluxes considered are omitted or considered implicitly in the Global Carbon Budget as presented by Le Quéré et al. (2018). I recommend publication subject to addressing the concerns below

Response: Again, we thank the reviewer for this positive overall assessment. We also acknowledge that our paper will not be the last word on these numbers. For that reason, we have entitled it ‘Towards a more complete quantification of the global carbon cycle’. Global carbon budgets are continually evolving to reflect changing real-world fluxes, advancing scientific understanding, and the conceptual terms used to summarise observed or inferred fluxes into quantities that are deemed to be relevant to the scientific and policy-making community. Our paper aims to contribute towards that process of continual improvement.

Reviewer comment: Major comment My only substantial concern relates to Section 12. The results presented by Kirschbaum et al. potentially tie in with very active discussion over the extent to which CO₂ fertilisation of leaf photosynthesis is propagated through to ecosystem-level increases in carbon storage (e.g. Körner, 2017, 2006; Luo et al., 2004; Medlyn et al., 2015). It is relevant to mention this however I find Section 12 generally a step too far. For instance, in section 12.1 it is stated “any carbon uptake by forests is likely to be largely due to their disturbance history”. This is a valid and highly-relevant hypothesis, but it is only a hypothesis. We currently do not know the relative contributions of CO₂ fertilisation versus forest demography with any certainty. This should be reflected in the discussion.

Response: It had not been our intent to provide a conclusion on that ongoing debate about the various contributing factors. The specific statement in question that ‘any carbon uptake by forests is likely to be largely due to their disturbance history’ was meant to primarily refer to the pattern in individual stands for which the

normal growth cycle presumably over-rides any other growth-promoting factors. We had not intended it to be seen as directly applicable to global forest carbon balances.

We have therefore changed that section now primarily by removing that offending sentence. We have also further restructured that section with some additional minor wording changes. We hope this rectifies the concern expressed by the reviewer.

Reviewer comment: Similarly, Arneth et al. (2017) is cited relating to the importance of biophysical drivers (pg. 12, line 19), but a key conclusion of Arneth et al. is that because the land-use and management change emissions may be systematically underestimated in the budget, this implies that the terrestrial “residual” sink may have previously been underestimated. Thus, it may be that the calculations presented by Kirschbaum et al. do not imply an overestimation of the carbon sink in global vegetation models, but instead account for a missing portion of the budget that balances previously underestimated land-use and management change emissions. This possibility should be explicitly laid out.

Response: To capture the point made by Arneth et al. (2017), we have added an extra sentence to Section 12.1: ‘subtler disturbance related effects on woody biomass are difficult to capture fully at the global scale and may have led to past underestimation of land-use change related carbon emissions (Arneth et al. 2017)....’

Reviewer comment: Finally, the soil organic carbon section (12.4) is extremely speculative and doesn’t really fit in the framework of the manuscript. Yes, a change of 0.4

Response: The reviewer’s comment ended abruptly, and we are not sure what (s)he intended to say to complete the review point. At the same time, we agree with the reviewer of the speculative nature of this Section, but that is precisely the point it was trying to make. Changes in soil carbon constitute the largest unknown contribution in the global budget. We may be able to improve the quantification of various flux by 100 MtC yr⁻¹ or so, but at the same time, soil carbon may change by 1 GtC yr⁻¹ in one direction or another without anyone being able to quantify it. We need to remain conscious of the uncertainty in our budget estimates when soil-carbon changes alone have such a large level of uncertainty. We, therefore, believe that this is an important section of the paper and have retained it.

Reviewer comment: Overall, in my opinion this section needs to be much more balanced, laying out the various competing hypotheses, so as to reflect a review, rather than an opinion piece.

Response: We are unsure what ‘section’ the reviewer is referring to here. If the reviewer is referring to Section 12.4, we see little ‘opinion’ in that section as we merely point out the existing uncertainty. If the reviewer refers to the sum-total of Sections 12.1 to 12.4, we aimed to do exactly what the reviewer has asked us to do: we very briefly summarised the main fluxes that could contribute to an enhanced global terrestrial sink. We tried to avoid any conclusive statement as to our view of the contributing components but simply summarised the existing literature. We are unsure what else the reviewer might want us to do to those sections.

Minor comments

Reviewer comment: Pg. 1, line 38. “net additions”? “the oceans overall are”?

Response: Changes made as suggested.

Reviewer comment: Pg. 2, line 5. The budget is based on terrestrial biosphere models (TBMs) run offline, not Earth System Models.

Response: Change made as suggested.

Reviewer comment: Pg. 4, line 11. Ro or Rd?

Response: It should have been R_d. Change made to correct that.

Reviewer comment: Pg. 5, para 2. Wood product pools are included in many, if not all, of the TBMs used in Le Quéré et al. (2018). Stocks have rarely been published, which unfortunately does not facilitate a comparison, but this flux has not entirely been neglected. This should be recognised in the text.

Response: We were aware of that inclusion of wood products in past budgets and referred to it in the original text on three separate occasions:

Page 2, line 34: *This flux [wood products] has already been included in net land-use change calculations (Le Quere et al., 2018), ...*

Page 4, line 30: *Le Quere et al. (2018) included a simple term in the calculations of net land-use change that accounted for harvested-wood products.*

Page 9, lines 8-11: *For greater transparency, it would also be desirable to explicitly include harvested-wood products and landfill pools. The associated carbon flux is already included under the net-land-use calculations (Le Quere et al., 2018). Inclusion of a harvested-wood-products pool, therefore, would not affect the size of the residual sink, but it would require a corresponding adjustment of the net land-use-change flux.*

We believe that three mentions of that inclusion of wood products in prior budgets is adequate, if not excessive already, and believe it would not be warranted to refer to its inclusion yet another time.

Reviewer comment: Pg. 7, line 8. “some extra inputs mineral weathering” – does not seem to make sense. Please rephrase.

Response: This sentence needed an extra ‘from’ to say ‘some extra inputs from mineral weathering’. That has now been corrected.

Reviewer comment: Pg. 7, line 10. Cole et al. 2009 or 2007 (cf. Table 2)?

Response: Thank you for spotting that inconsistency. It should have read ‘2007’ in all references to ‘Cole’. That has now been corrected.

Reviewer comment: Pg. 7, line 18/19. Repetition of material from two paragraph previously.

Response: This partial repetition stems from the initial mention in a context where it simply listed all river related fluxes and storage items, while the second mention relates it to the fluxes and quantities that are relevant to the global carbon budget. We, therefore, regard some repetition as appropriate because the contexts are slightly different. However, we have shortened both sections to reduce the extent of that repetition.

Reviewer comment: Table 2 is not the easiest to follow. Use of vertical lines for grouping into sections and bold text to highlight the values being carried forward would help readability.

Response: To improve an understanding of the flow and grouping of the table, we have bolded our resultant estimate to indicate the numbers being carried forward. We have also omitted some of the vertical lines so that the retained vertical lines now indicate the logical grouping of some of the values.

Response to Reviewer #2

Reviewer comment: *The manuscript by Kirschbaum and others is a well-written summary of existing estimates of small C fluxes that should not be excluded from global C syntheses, as the authors demonstrate. I feel that it is publishable after the authors consider a number of minor points for clarity and a few more major revisions regarding deposition pathways. Namely, some dry and wet deposition terms are attributed to a flux to the ocean but in reality go to both land and ocean. In a few instances the authors appeared to be overly critical of existing budgets without justification in my opinion.*

Response: We like to thank the reviewer for the favourable overall assessment of the manuscript. We have addressed the specific points of criticisms in our itemised responses below.

Reviewer comment: *The paper would also very strongly benefit from a table of abbreviations (especially equation 1!).*

Response: We have general sympathy with the notion that it can often be useful to provide easy access to abbreviations used in any paper. However, in this specific paper, almost all abbreviations are used only once – for specific equations – and then immediately described in the text adjacent to the respective equations. The only abbreviations used on more than one occasion were ΔB and $\Delta B_{\text{incl.UC}}$. We have renamed these symbols now into ΔB_{phys} and ΔB_{act} to stand for biomass changes due to physiological factors and actual changes, respectively. We regard these terms as much more intuitive. We expect that with this change, it is no longer warranted to include an additional table of abbreviations.

Reviewer comment: *Figure 1 is nice but doesn't link pools and fluxes with the abbreviations used in the text.*

Response: We are unsure how to respond to that comment. Figure 1 gives the very abbreviated form of the global carbon cycle, with only five identified fluxes (fossil fuels, cement manufacture, land use change, ocean uptake and residual terrestrial uptake). The main purpose of our paper was to present a more differentiated picture and add additional pools and fluxes to the budget. So, the very essence of our paper is that these additional pools are not included in the simplified version of the global budget. Showing that difference is the essence of our paper. Thus, there is little correspondence between the pools and fluxes in Figure 1, and our more complete list of pools and fluxes. It would thus be impossible to do what the reviewer is asking us to do.

Reviewer comment: *In section 2, 'The shallow ocean is too small for significant carbon storage, but the deep ocean has a huge carbon-storage capacity' seems inconsistent with the goal of the paper to quantify small C fluxes*

Response: We see no inconsistency between there being a 'huge capacity', yet there being only a relatively small annual flux into that reservoir. The relatively small annual flux is still large and important in relation to the anthropogenic disturbance of the system even though it is small relative to the potential magnitude of carbon storage in the deep ocean. It just means that the flux into the reservoir has virtually no feedback effect on subsequent fluxes into that reservoir. The flux, is instead controlled by other factors. As we see no inconsistency between these statements, we have made no changes to the text.

Reviewer comment: *'As these organisms are eaten by larger organisms' is true, but small organisms also die.*

Response: We have modified that statement to include the possible extra carbon fate.

Reviewer comment: *Regarding 'However, we believe that a more explicit representation of this pool would be desirable for greater transparency.' Yes, everyone does, but writing it as such doesn't make it clear if this will be addressed in the paper.*

Response: We have an extra part to this sentence to make it clear that such quantification is part of the present paper.

Reviewer comment: 'However, under anaerobic conditions, breakdown effectively ceases completely' and 'never breaks down' are slight elaborations. Over meaningful time scales to the contemporary climate system perhaps. (See also Table 1 'permanently'. Readers with a long view of time may disagree.)

Response: The text tries to make that assessment within the context of the contemporary carbon cycle, which is the relevant focus of the present paper. The statement is not meant to refer to a geological context. We have therefore modified that sentence to indicate that permanence refers only to a time frame relevant for carbon management.

Reviewer comment: Wording can be simplified in many places. For example, 'Forbes et al. (2006) estimated this flux to be only small at less than 10 MtC yr⁻¹. Could lose 'only small at'.

Response: We have worked through the text once more and further tightened and simplified any text where appropriate.

Reviewer comment: 'any transfers to the ocean' in section 9 could also be transfers to land to the extent that NMVOCs create aerosols and cloud condensation nuclei that are subsequently deposited to the surface at some point. Later in the section dry deposition (can also be wet deposition) is mentioned. This needs to be integrated more strongly with the material above. Figure 7 also needs to be modified; dust, NMVOCs, charcoal and the like also land on land.

Response: We are well aware of the facts mentioned by the reviewer, and these factors have been properly included in our analysis:

- The dust deposition used in our calculations based on the work of Mahowald et al. (2005) specifically refers to dust transfer from land to oceans.
- The estimate of charcoal transfer of Forbes et al. (2006) specifically referred to charcoal transfer to the oceans
- For the transfer of NMVOC-derived compounds, we explicitly estimated the proportional deposition over land vs the oceans. This is described in detail in Supplementary Materials: "For species that are subject to dry and wet deposition, we partitioned the ocean flux as follows. We used the modelled global distribution of dry deposition fluxes to the Earth's surface of each species and accounted for deposition to the ocean using the model's land-sea mask information. Total dry deposition to the land and the ocean were then calculated by integrating the respective fluxes over the land and the ocean. In the model version used here, wet deposition fluxes were output as zonally averaged 2-dimensional fields. Therefore, we needed to partition the global wet deposition fluxes to the ocean using 3-dimensional global distributions of the species and weighted them by the global distribution of total precipitation rates."

So, we fully agree with the reviewer's position by the reviewer and are well aware of the importance of separating ocean and land deposition, and we believe that throughout the paper, we have used the appropriate data sources for estimating fluxes to the oceans.

Reviewer comment: Section 12.1 for some reason dismisses a large body of literature demonstrating that 'older' forests can take up substantial amounts of carbon, e.g. <https://www.nature.com/articles/nature07276>.

Response: Section 12.1 stated: 'Forest growth tends to be highest in young stands and decreases as stands age'.

That position is well-supported by the general forestry literature. Even the nature article by Luysaert et al. (2008) cited by the reviewer agreed with that statement and showed that net ecosystem productivity of younger stands was about twice as high as that of older stands and trended towards carbon neutrality for the oldest stands in their data set.

At the same time, we also agree with the reviewer's point that 'older forests can take up substantial amounts of carbon'. We make no statement that would contradict that position. We simply state that younger forests can have a higher net ecosystem productivity than older forests.

So, our statement is well supported by a large body of forestry literature, including Ryan et al. (1997) and Kurz and Apps (1999) that have been cited in our paper, and are not contradicted by the Luyssaert et al. (2008) paper referred to by the reviewer. We, therefore, believe that this criticism is not justified, and the reviewer criticises statements that are not actually made anywhere in our paper. That makes it difficult to know how we could respond to that criticism.

Reviewer comment: This sentence is an overly-harsh critique of the hard work that goes into global carbon budgeting: However, the global carbon budget in its currently used simplified form is incomplete and, therefore, does not provide appropriate guidance on the way anthropogenic and natural processes interact to lead to the observed increases in atmospheric concentrations.

Response: We do not mean to be harshly critical of the global carbon budget. We recognise that overall, it provides timely and relevant information on the key carbon fluxes. Nonetheless, as we are trying to point out in our manuscripts, there are additional tweaks through inclusion of additional fluxes that would make the budget even more accurate, and that this tweak would have important consequences for our overall understanding of the current role of the biosphere, in particular. So, we think the essence of our statement is correct, but we have reworded it to make it sound less critical of the valuable ongoing work on the global carbon budget.

Reviewer comment: Table 2: waterway is one word.

Response: That has now been corrected throughout the manuscript

Reviewer comment: Simultaneous red and green should be avoided in Figure 5.

Response: We have redrawn the figure to avoid that colour conflict.

Reviewer comment: Figure 6 is somewhat underwhelming.

Response: Our paper is trying to communicate with a wide range of potential readers with varying levels of background knowledge. Figure 6 probably contains little information for the expert reader, but we do believe that for a reader with less expert knowledge, the figure provides a useful short summary of the relevant fluxes and the main compounds contributing to those fluxes. We have, therefore, retained that figure.

References

Barlaz, M.A.: Forest products decomposition in municipal solid waste landfills. *Waste Manage.*, 26, 321–333, 2006.

Forbes, M.S., Raison, R.J., and Skjemstad, J.O.: Formation, transformation and transport of black carbon (charcoal) in terrestrial and aquatic ecosystems. *Sci. Total Environ.*, 370, 190–206, 2006.

Kurz, W.A. and Apps, M.J.: A 70-year retrospective analysis of carbon fluxes in the Canadian forest sector. *Ecol. Appl.*, 9, 526–547, 1999.

Lauk, C., Haberl, H., Erb, K.H., Gingrich, S., and Krausmann, F.: Global socioeconomic carbon stocks in long-lived products 1900–2008. *Environ. Res. Lett.*, 7, Article Number: 034023, 2012.

Sebastiaan Luyssaert, S., Schulze, E.-D., Börner, A., Knohl, A., Hessenmöller, D., Law, B.E., Ciais, P. and Grace, J. (2008). Old-growth forests as global carbon sinks. *Nature*, 455, 213–215.

Mahowald, N.M., Baker, A.R., Bergametti, G., Brooks, N., Duce, R.A., Jickells, T.D., Kubilay, N., Prospero, J.M., and Tegen, I: Atmospheric global dust cycle and iron inputs to the ocean. *Global Biogeochem. Cycles*, 19, Article
5 Number: GB4025, 2005.

Ryan, M.G., Binkley, D., and Fownes, J.H.: Age-related decline in forest productivity: Pattern and process. *Adv. Ecol. Res.*, 27, 213–262, 1997.

Towards a more complete quantification of the global carbon cycle

Miko U.F. Kirschbaum¹, Guang Zeng², Fabiano Ximenes³, Donna L. Giltrap¹, John R. Zeldis⁴

¹ Landcare Research – Manaaki Whenua, Private Bag 11052, Palmerston North, New Zealand

5 ² National Institute of Water & Atmospheric Research, Private Bag 14901, Wellington 6021, New Zealand

³ Forest Science Unit, New South Wales Department of Primary Industries, Locked Bag 5123, Parramatta NSW 2150, Australia

⁴ National Institute of Water & Atmospheric Research, PO Box 8602, Christchurch 8011, New Zealand

10 *Correspondence to:* Miko U.F. Kirschbaum (KirschbaumM@LandcareResearch.co.nz)

Abstract.

The main components of global carbon budget calculations are the emissions from burning fossil fuels, cement production, and net land-use change, partly balanced by ocean CO₂ uptake and CO₂ increase in the atmosphere. The 15 **remaining** difference between these terms is referred to as the residual sink, assumed to correspond to increasing carbon storage in the terrestrial biosphere (~~ΔB~~-through physiological plant responses to changing conditions (ΔB_{phys}). It is often used to constrain carbon exchange in global earth-system models. More broadly, it guides expectations of autonomous changes in global carbon stocks in response to climatic changes, including increasing CO₂, that may add to, or subtract from, anthropogenic CO₂ emissions.

20 However, a budget with only these terms omits some important additional fluxes that are important for correctly inferring ~~ΔBΔB_{phys}~~. They are cement carbonation and fluxes into increasing pools of plastic, bitumen, harvested-wood products, and landfill deposition after disposal of these products, and carbon fluxes to the oceans via wind erosion and non-CO₂ fluxes of the intermediate break-down products of methane and other volatile organic compounds. While the global budget includes river transport of dissolved inorganic carbon, it omits river transport of dissolved and 25 particulate organic carbon, and the deposition of carbon in inland water bodies.

Each one of these terms is relatively small, but together they can constitute important additional fluxes that would significantly reduce the size of the inferred ~~ΔBΔB_{phys}~~. We estimate here that inclusion of these fluxes would reduce ~~ΔBΔB_{phys}~~ from the currently reported 3.6 down to **only** about 2.1 GtC yr⁻¹ (excluding losses from land-use change). The implicit reduction in the size of ~~ΔBΔB_{phys}~~ has important implications for the inferred magnitude of current-day 30 biospheric net carbon uptake and the consequent potential of future biospheric feedbacks to amplify or negate net anthropogenic CO₂ emissions.

1. Introduction

In its summarised form, the global carbon cycle is usually expressed in the form of six main fluxes (Le Quere et al., 35 2018; Figure 1). Carbon is added to the atmosphere by the burning of fossil fuels (9.0 GtC yr⁻¹), cement production (0.4 GtC yr⁻¹) and ongoing deforestation, mainly in the tropics (1.3 GtC yr⁻¹). Some fossil fuels (0.4 GtC yr⁻¹) are also utilised for the manufacture of other products, like plastics, or are incompletely combusted and thus do not directly emit CO₂ to the atmosphere. The atmospheric CO₂ concentration has increased to over 400 ppm through annual **net** additions of about 4.7 GtC yr⁻¹ whereas the oceans **overall** are still close to their pre-industrial effective equilibrium

concentration of 280 ppm. This difference constitutes a driving force for ocean CO₂ uptake, estimated at 2.4 GtC yr⁻¹ (Le Quere et al., 2018).

Summing these various fluxes results in an imbalance of 3.6 GtC yr⁻¹, often referred to as the 'residual sink'. This flux cannot be directly and independently estimated; but is derived as the residual remaining after estimation of the other terms. In the most recent budget, this has been separated into an estimated 'land sink', based on **earth-system/terrestrial biosphere** models, (TBM_s), and a remaining 'budget imbalance' (Le Quere et al., 2018).

The size of the residual sink is often implicitly or explicitly equated with carbon uptake by the terrestrial biosphere (e.g. Ciais et al., 2013; Sitch et al., 2015; Arneeth et al., 2017; Huntzinger et al., 2017). A sink of 3.6 GtC yr⁻¹ suggests that one third of anthropogenic emissions might be balanced by biospheric carbon uptake and storage. The size of this flux is even more important for future trends in biospheric uptake that could provide an important positive or negative feedback for atmospheric CO₂ changes (Cramer et al., 2001; Jones et al., 2013). If the magnitude of terrestrial uptake is over- or underestimated, it would lead to incorrect inference about the strength of future feedback processes from the terrestrial biosphere on the earth's net carbon budget.

However, in the global carbon budget as presented in Figure 1, several important fluxes have been omitted. In the present work, we aim to provide a quantification of these additional terms based on values found in the existing literature or derived in the current work, and thereby more completely quantify the global carbon cycle. In addition, we estimate the **actual** increase in carbon stored in the terrestrial biosphere, $\Delta B_{\text{incl-LUC}} \Delta B_{\text{act}}$, by explicitly accounting for the carbon flux into additional carbon-storage pools or through pathways not previously included in global budget calculations. We also estimate the net change in carbon stored in the terrestrial biosphere, $\Delta B \Delta B_{\text{phys}}$, to refer to the change in stored carbon **through physiological plant responses but** excluding the effects of land-use change.

Hence, the present works aims to quantify these additional terms:

- 1) Net increases in the pools of harvested-wood products, plastic, bitumen, rubber, leather and textiles while they are in service;
- 2) Net increases of carbon in anaerobic landfills after subsequent disposal of these products;
- 3) The carbonation of previously manufactured cement products;
- 4) River transport from the land to the oceans as dissolved or particulate organic carbon;
- 5) Carbon deposition in inland water bodies;
- 6) Transfer of carbon from the land to **the** oceans via aeolian transport either attached to mineral dust or as charcoal;
- 7) Fluxes of non-CO₂ **carbonaceous** gases, principally methane and NMVOCs (non-methane volatile organic compounds) and their intermediate break-down products.

Of these, CO₂ fluxes associated with cement carbonation (Xi et al., 2016), and carbon deposition in fresh-water bodies (e.g. Regnier et al., 2013) constitute obvious fluxes from the atmosphere into relevant storage pools that have not **previously** been included in **the**-global budgets. There is also a sizeable net flux into the pool of harvested-wood products (Lauk et al., 2012). This flux has already been included in net land-use change calculations (Le Quere et al., 2018), but in the interest of transparency, it would be preferable if that flux were quantified more explicitly.

Net carbon fluxes into the pools of plastic and bitumen and subsequently into anaerobic landfills have also been included indirectly by accounting for only an assumed fraction of fossil-fuel carbon being oxidised (e.g. Marland and Rotty, 1984; Le Quere et al., 2018). A small fraction of fossil fuels is used for **manufacturing/manufactured** products,

Formatted: Indent: Left: 0 cm, Hanging: 0.5 cm, Line spacing: 1.5 lines

such as plastic and bitumen, and of the fossil fuels that are burnt, another small fraction is only incompletely combusted leading to less than 100% being converted to CO₂ (Marland and Rotty, 1984). Based on these considerations, Marland and Rotty (1984) estimated oxidation fractions of 98%, 91.8% and 98.2% for the utilisation of gas, liquid and solid fuels, respectively. These terms are then applied to fossil-fuel production data to derive fossil-fuel-based CO₂ emission rates (e.g. Andres et al., 2012). In the interests of greater transparency, it would be desirable, however, if fluxes through these key product pathways were more explicitly accounted and reported in future global emission budgets.

Carbon transport to the oceans through river transport (Regnier et al., 2013), aeolian fluxes (e.g. Romankevich et al., 2009) or gas fluxes by carbonaceous compounds other than CO₂ all constitute additional carbon fluxes from the land to the oceans. These fluxes are only incompletely accounted for in the standard quantification of the global carbon cycle, and a more complete quantification is given below. The significance of the different terms in land-ocean exchange are discussed in the next section.

2. Ocean Exchange

In deriving the global carbon budget, Le Quere et al., (2018) used estimates of air–ocean CO₂ exchange rates (T_{ia} in Fig. 2) and added the transport of inorganic carbon via river transport (T_{ir} , Fig. 2) with the aim of describing the anthropogenic carbon budget (Jacobson et al., 2007; Le Quere et al., 2018). However, this omits other important transport pathways as illustrated in Figure 2. The ultimate key fluxes are the net transport of carbon from the shallow to the deep ocean (or to ocean-floor deposition in shallow seas) as either inorganic CO₂ (H₂CO₃, HCO₃⁻, CO₃²⁻), including CaCO₃ in solid form CaCO₃, or in any soluble or particulate organic form. Hence, the relevant total carbon transfer, T_c , can be described as $T_c = T_{id} + T_{od}$ where T_{id} and T_{od} are the net carbon transfers to the deep ocean of inorganic and organic carbon, respectively. The shallow ocean is too small for significant carbon storage, but the deep ocean has a huge large carbon-storage capacity. The shallow ocean is important, however, as the interface between the ocean and the atmosphere and where pCO₂ measurements are taken for the estimation of net CO₂ exchange between the atmosphere and the shallow ocean.

In the ocean, organic and inorganic forms of carbon continuously interchange. Inorganic carbon is fixed and converted into organic forms by photosynthetic organisms. As these organisms die or are eaten by larger organisms, carbon is respired in inorganic form. The sizes of these conversion fluxes are not important in the present context, as carbon can ultimately be transferred to depth in either organic or inorganic form. The net flux of inorganic carbon from the deep ocean may even be negative (outgassing), with net carbon transfer to depth reliant on organic carbon transfer.

As transfers T_{id} and T_{od} are difficult to measure directly, the flux T_c is normally approximated as $T_c = T_{ia} + T_{ir}$ while the fluxes of organic carbon from atmospheric transfer or river transport, T_{oa} and T_{or} , are ignored and omitted from the estimated global fluxes. Instead, we propose that the more appropriate total flux should be calculated as: $T_c = T_{ia} + T_{ir} + T_{oa} + T_{or}$. Below, we quantify the different fluxes of organic carbon to the oceans to complete the overall sums.

3. Calculation Details

For comparison between the residual sink and estimates of carbon exchange of the land biosphere, we used the data given by Le Quere et al. (2018) as land sink and budget imbalance for different years. Previous carbon budgets (e.g. Le Quere et al., 2016) provided numbers denoted as residual sink activity. In the latest budget, this has been

disaggregated into a land sink, estimated from biosphere models, and a budget imbalance term (e.g. Le Quere et al., 2018). The sum of these two terms equates to the previously given residual sink, RS_r .

Changes in the terrestrial C steekstocks were calculated as:

$$AB = R\Delta B_{phys} = S_r - R_d - R_p - R_i - D - V - C - P - B - L + N \quad (1)$$

$$5 \quad \Delta B_{ineLUC} = \Delta B_{\Delta act} = \Delta B_{phys} + LUC \quad (2)$$

where R_d is river transport as dissolved organic carbon, R_p is river transport as particulate organic carbon, R_i is carbon deposition in inland water ways, D is carbon transport to the oceans as aeolian dust deposits, V is transfer from volatile intermediate oxidation products of methane and NMVOCs, C is carbon storage in cement carbonation, P , B and L are the changes in carbon stored in plastics, bitumen and landfills, respectively, and N is the non-oxidised fraction of fossil consumption that has been implicitly included in previous budgets. The terms P , B and L therefore largely cancel out the term N , but the calculations are made more explicit here.

The term ΔB_{ineLUC} refers to the actual change in the total terrestrial biosphere carbon stocks, including changes due to land-use change, and $\Delta B_{\Delta act}$ refers to biospheric carbon-stock changes due to physiological and age-class effects, but excluding land-use change. LUC is the carbon-stock change due to land-use change with negative numbers denoting net losses to the atmosphere. Of these various components, no temporal trends were available for R_d , R_p , R_i , D and V , but temporal patterns could be included for P , B , C , L and N based on the work of Lauk et al. (2012) and Xi et al. (2016) and calculated, following Marland and Rotty (1984), as:

$$N = F (0.02 g + 0.082 l + 0.018 s) \quad (3)$$

where F is total fossil-fuel consumption and g , l and s are the percentages of gas, liquid and solid fuel in the global mix of fossil fuels, estimated as constant percentages of 17.0%, 41.8% and 41.2% since 1959, and the constants in eq. 3 have been taken from Marland and Rotty (1984).

4. Wood products, plastics, bitumen, cement carbonation

For harvested-wood products, plastic and bitumen in service by human societies, the relevant quantity in the present context is the net increase in the size of these pools. At the end of their service lives, plastic and harvested-wood products, especially paper products, may be re-used, recycled, or disposed of either by incineration or disposal in landfills. If they are incinerated in waste-to-energy facilities, CO_2 is released to the atmosphere immediately, and if they are re-used or recycled, the products re-enter the 'in-service' pool. Alternatively, these products may be deposited in landfills in countries that use landfills as part of their waste management strategies, which will be discussed in the next Section.

For harvested-wood products in service, net increases in carbon stocks primarily correspond to the pool of long-lived structural wood products, such as housing frames. Paper products, on the other hand, tend to have short service lives and do not build up to sizeable pools even though fluxes through these pools can be substantial. This can include multiple passes through the active-service pool because paper products may be recycled repeatedly before eventual disposal. Le Quere et al. (2018) included a simple term in the calculations of net land-use change that accounted for harvested-wood products. They assumed that a fraction of the wood lost through land-use change was not directly lost as CO_2 to the atmosphere but retained in harvested-wood products. However, we believe that a more explicit

representation of this pool, as provided through the work of Winjum et al. (1998) and Lauk et al. (2012), would be desirable for greater transparency.

In the case of cement carbonation, the flux is associated with the degeneration of previously manufactured cement. Cement manufacture is essentially the calcination of CaCO_3 into CaO under high temperature. The resultant CO_2 release is included in global carbon budgets (Andrew, 2018) and accounts for about 4% of total anthropogenic CO_2 emissions (Le Quere et al., 2018). When cement is subsequently exposed to rain and natural CO_2 concentrations, the process is reversed, and CO_2 is reabsorbed, replacing oxygen bound to calcium (Xi et al., 2016). ~~This causes the gradual degradation of cement, with the rate of degradation essentially determined by the slow diffusion of CO_2 into any cement products.~~

Essentially all cement is subject to that kind of degradation, with its rate decreasing with the thickness of the cement layer. Thinner layers of mortar therefore degrade faster than more solid concrete structures. When a building is demolished, cement carbonation tends to increase as cement becomes fragmented, thereby opening new surfaces that ~~allows more rapid diffusional penetration of CO_2~~ . The rate of cement carbonation can, therefore, be approximated as being proportional to total cumulative past cement production. Hence, global carbonation rates were likely to have been low in the 1950s, then increased gradually to the 1990s (Fig. 3a), with much more substantial increases since then. Using statistics of historical cement production in different categories, Xi et al. (2016) ~~estimated recent uptake rates of about 250 MtC yr^{-1} , with uptake rates expected to continue increasing into the future.~~

The socio-economic models of Kayo et al. (2015) and Brunet-Navarro et al. (2016) have shown that in poorer societies, wood use per person increases with increasing wealth (quantified as gross domestic product, GDP, per capita, cp^{-1}). However, that relationship saturates at intermediate values of GDP cp^{-1} and even becomes negative for the wealthiest societies. Lauk et al. (2012) estimated that humans own on average approximately 1 tC cp^{-1} in harvested-wood products. If that figure ~~remainedis remaining~~ constant over time, one could assume an annual increase of the global pool by about 80 MtC yr^{-1} purely driven by global population growth. If wood use per person is also increasing, as shown by Kayo et al. (2015), it would result in an increase in the global harvested-wood-products pool by more than 80 MtC yr^{-1} . Winjum et al. (1998) and Lauk et al. (2012) estimated changes in the harvested-wood products pool from analysis of wood-production statistics and assumption ~~aboutof~~ product longevities. Winjum et al. (1998) estimated an annual increase of about 140 MtC yr^{-1} , while Lauk et al. (2012) provided a slightly smaller estimate of recent increases by just under 100 MtC yr^{-1} . ~~They~~Lauk et al. (2012) also provided historical estimates over the 20th century (Fig. 3a).

However, for most countries and wood-product categories (paper, wood panels, and sawn wood), there are no reliable service life factors. Global analyses therefore have had to rely on the use of generic factors, such as IPCC default Tier 2 half-lives (IPCC 2014). Lauk et al. (2012) considered the need to use these generic factors as the primary cause of the large uncertainties in their estimated carbon fluxes into harvested-wood-product pools. Lauk et al. (2012) also estimated fluxes into the pools of bitumen, used mainly for road construction, and plastics (Fig. 3a). Fluxes started from very low values before 1950 but have increased steadily and are now similar to fluxes into the pool of harvested-wood products.

In the case of cement carbonation, the flux is associated with the degeneration of previously manufactured cement. Cement manufacture is essentially the calcination of CaCO_3 into CaO under high temperature. The resultant CO_2 release is included in global carbon budgets (Andrew, 2018) and accounts for about 4% of total anthropogenic CO_2 emissions (Le Quere et al., 2018; Figure 1). When cement is subsequently exposed to rain and natural CO_2

concentrations, the process is reversed, and CO₂ is reabsorbed, replacing oxygen bound to calcium (Xi et al., 2016). This causes the gradual degradation of cement, with the rate of degradation determined by the slow diffusion of CO₂ into any cement products.

All cement is subject to that kind of degradation, with its rate decreasing with the thickness of the cement layer.

- 5 Thinner layers of mortar therefore degrade faster than more solid concrete structures. When a building is demolished, cement carbonation tends to increase as cement becomes fragmented, thereby opening new surfaces that assists the diffusional penetration of CO₂. The rate of cement carbonation can, therefore, be approximated as being proportional to total cumulative past cement production. Hence, global carbonation rates were likely to have been low in the 1950s, then increased gradually to the 1990s (Fig. 3a), with much more substantial increases since then. Using statistics of historical cement production in different categories, Xi et al. (2016) estimated recent uptake rates through carbonation of about 250 MtC yr⁻¹, with uptake rates expected to continue increasing into the future.

- 15 The combined flux from these four fluxes (cement carbonation and increasing pools of harvested wood products, plastic and bitumen) was estimated to have been less than 50 MtC yr⁻¹ in 1950, but increased steadily to about 300 MtC yr⁻¹ by 2000 (Fig. 3b). The rate of uptake has increased more sharply since then, driven mainly by increasing cement carbonation, and is estimated to have reached about 450 MtC yr⁻¹ by 2010 (Fig. 3b).

5. Landfill Storage

At the end of their service lives, products may be disposed of in landfills, where conditions may be aerobic, semi-aerobic or anaerobic depending on their management (IPCC 2006). If materials are kept under anaerobic conditions, their effective storage life can be extended substantially, with very slow decomposition and resultant carbon loss (Wang et al., 2011, 2015; Ximenes et al., 2015, 2018, 2019).

Wood and plastics are particularly persistent after disposal unless they are incinerated. Bitumen is not usually disposed of, but if, when roads are renewed, old bitumen is typically recycled, with only minor losses (Lauk et al., 2012). Textiles, rubber and leather make additional minor contributions to total landfill carbon stocks. With all categories added together, anaerobic landfills can thus store large amounts of carbon.

- 25 Lauk et al. (2012) estimated total annual disposal rates of various key products (Fig. 4), estimated at nearly 500 MtC yr⁻¹. While Figure 4 clearly shows the historical pattern of product disposal, it does not indicate what quantities of products are disposed of in anaerobic landfills. To the best of our knowledge, there have been no prior estimates of global net carbon stock changes in landfills. We have therefore attempted to provide a first global estimate of waste disposal in anaerobic landfills and consequent annual changes in landfill carbon stocks (Table 1).

- 30 Accounting for annual landfill fluxes of different waste streams, their dry-matter percentages, carbon contents and relative permanence under anaerobic conditions, we estimated changes in long-term carbon pools in landfills for different product categories. The temporal pattern of breakdown in landfills is not clear. One normally describes the breakdown of products as an exponential decay process which can be described with a simple decay constant constants or its inverse, the residence times. However, under anaerobic conditions, breakdown effectively ceases completely, and a permanence factor essentially separates products into a fraction that breaks down over a relatively short time frame and a second fraction that never-breaks-down.does not break down within a time frame relevant for carbon management. The sizes of these fractions are determined by their associated degradability, such as cellulose to lignin ratios, and the biophysical conditions within landfill sites (e.g. Barlaz, 2006).

Paper and paperboard constituted the largest disposal category, but because of its relatively fast rate of degradation (Wang et al., 2011, 2015; Ximenes et al., 2015, 2018), its contribution to increasing carbon stocks is only minor. Although less wood and engineered wood products (e.g. plywood, particleboard) are disposed of in landfills than of paper and paperboard, it leads to a higher estimated storage flux because wood is highly resistance to degradation under anaerobic conditions. (Ximenes et al., 2019). Plastics have the highest estimated storage flux (42 MtC yr⁻¹) because of their high disposal rate, high carbon content and very high persistence.

Using the detailed data and assumptions in Table 1, we calculated a net carbon change in landfill storage by 88 MtC yr⁻¹.

6. River Transport

10 A large amount of carbon is transported from the terrestrial biosphere to the oceans through river flow. Carbon can be transported as dissolved inorganic (DIC), dissolved organic (DOC) or particulate organic (POC) carbon (Ward et al., 2017). These fluxes are difficult to quantify because of the enormous diversity of river systems (Regnier et al., 2013; Mendonca et al., 2017), and the large episodic contribution to some fluxes, especially of particulate organic carbon, by infrequent flood events. Net fluxes into and out of inland water systems also consist of multiple entry points and
15 large outgassing as some organic materials are broken down and respired as CO₂ before they can be deposited in lake sediments or the oceans while simultaneously, some new carbon is fixed through aquatic photosynthesis.

Mendonca et al. (2017) documented the largest reported emissions rates per unit area for small reservoirs, with variability that extended over three orders of magnitude, yet global estimates had to be based on a mere 59 available point estimates. The combined surface area of these smaller reservoirs is fortunately much smaller than that of large
20 lakes which reduce the importance of that uncertainty. Larger lakes had similar relative variabilities in observed rates but smaller averages. However, the small number of available observations clearly prevents the size of this globally important flux to be estimated with high confidence (e.g. Regnier et al., 2013).

Despite these difficulties, various authors have attempted to provide global estimates of the key fluxes (Table 2; Fig. 5). Most authors have estimated total influx to inland water-ways/waterways as between 2700 and 2900 MtC yr⁻¹, while the recent work by Drake et al. (2018) gave a much larger estimate of 5100 MtC yr⁻¹ (Table 2). Of that amount
25 of carbon entering inland water-ways/waterways, different authors have estimated outgassing losses between 750 and 2120 MtC yr⁻¹, with the estimate of Drake et al. (2018) again being much larger at 3900 MtC yr⁻¹. If one uses these estimates, together with some extra inputs from mineral weathering, this leaves about 1500 MtC yr⁻¹ to be either deposited in inland water bodies or transported to the oceans (Table 2).

30 Apart from the older work of Cole et al. (2009/2007), most other authors estimated total inland deposition as 600 MtC yr⁻¹ and total flux to the ocean as 900 MtC yr⁻¹. This is, broken down into estimated-dissolved-inorganic-carbon DIC flux of 450 MtC yr⁻¹, particulate-organic-POC flux of about 250 MtC yr⁻¹ and dissolved-organic-carbon DOC flux of 200 MtC yr⁻¹. Romankevich et al. (2009) estimated an additional contribution of 47 MtC yr⁻¹ from coastal erosion, ground-water influx and glacial run-off.

35 Considering the evidence used by the various authors, we consider total carbon flux to inland waterways to most likely be about 2900 MtC yr⁻¹ (Fig. 5; Table 2). About half of that carbon (1400 MtC yr⁻¹) is lost from water-ways/waterways by outgassing, although neither of those estimates are needed for explicit inclusion in the global budget.

The important ~~fluxes are flux~~ is the transport to the oceans, ~~estimated to be about 900 MtC yr⁻¹ and~~ consisting of 450 MtC yr⁻¹ DIC, 200 MtC yr⁻¹ DOC and 250 MtC yr⁻¹ POC, ~~with general convergence between different studies~~ (Table 2). The DIC flux is already included in the estimate of total inorganic ocean uptake, but the DOC and POC fluxes have not been included in the global summary numbers of Le Quere et al. (2018).

5 ~~In~~ addition, between 60 and 250 MtC yr⁻¹ are deposited in lakes and water reservoirs (Mendonca et al., 2017). Other studies have also included deposition in wetlands, floodplains and sediments for ~~a~~ total deposition ~~estimated to be~~ ~~estimate of~~ about 600 MtC yr⁻¹ in all inland water bodies (Tranvik et al., 2009; Aufdenkampe et al., 2011). This flux has also not yet been included in the global flux quantification of ~~ef~~ Le Quere et al. (2018).

7. Aeolian fluxes

10 Carbon can also be transported from the land to the oceans by aeolian transport through wind erosion of dust particles (Zender et al., 2003; Webb et al., 2012). These carbon fluxes to the ocean are not captured in air-sea CO₂ exchange but add to the total flux of carbon from the land to the ocean (see Fig. 2).

Romankevich (1984) estimated aeolian carbon flux as 320 MtC yr⁻¹, while Romankevich et al. (2009) estimated it as 96 MtC yr⁻¹. Estimates can also be based on independently estimating the annual flux of aeolian dust and their carbon concentrations. Mahowald et al. (2005) summarised the different available estimates of the total aeolian dust flux as 1500–2000 Mt(dust) yr⁻¹. Assuming source carbon concentrations between 1 and 2% (Webb et al., 2012; Chappell et al., 2013) and a 2.5-fold enrichment of carbon concentrations in dust relative to source concentrations (Webb et al., 2005), it leads to a global flux estimate of 50–100 MtC yr⁻¹.

8. Charcoal

20 A sizable fraction of annually produced biomass is burnt each year (Kuhlbusch and Crutzen, 1995). Savannah vegetation is particularly prone to annual burning, and a fraction of burnt material is not combusted completely but remains as charcoal, estimated as 50–270 MtC yr⁻¹ (Forbes et al., 2006). A small fraction of that will become airborne, either during fires themselves or in subsequent wind storms, and a small proportion of that airborne fraction will be transported to the oceans. Forbes et al. (2006) estimated this flux to be ~~only small at~~ less than 10 MtC yr⁻¹.

25 9. Methane and NMVOCs

The principal gas transfer of carbon to the oceans is via CO₂, but carbon can also reach the ocean in organic gaseous form (Fowler et al., 2009). The annual combined flux of methane and non-methane volatile organic compounds (NMVOCs) is estimated to be about 1.3 GtC yr⁻¹, with methane fluxes contributing about 500 MtC yr⁻¹ (Ciais et al., 2013) and NMVOCs, about 800 MtC yr⁻¹ (Fowler et al., 2009), more than half of which is isoprene. Most of these 30 compounds are oxidised in the troposphere, with methanol, methyl hydroperoxide and formaldehyde as key intermediate oxidation products (Fig. 6). If these compounds were fully oxidised to CO₂ in the atmosphere, there would be a simple closed loop between production by the terrestrial biosphere and atmospheric oxidation, but any transfers to the ocean by compounds other than CO₂ constitutes an additional carbon transfer from land to the ocean (see Fig. 2) that is not otherwise captured in the budget.

This transfer can be by direct transfer to the surface ocean or after prior solution in raindrops. This direct flux of methane and isoprene is probably small due to their low water solubility. However, under partial oxidation in the atmosphere, major intermediate products are methanol, organic acids, and formaldehyde, which are all highly soluble in water and can be deposited in the oceans as wet (after dissolution in rain or fog) or 'dry' deposition when gases dissolve directly in ocean water. As we are not aware of prior estimates of this flux, we have estimated wet and dry deposition of the relevant compounds here, [including a separation between land and ocean deposition](#) (Table 3). Details of the calculation methods are given in Supplemental Information.

The compounds in Table 3 show the quantitatively important intermediate oxidation products of methane, isoprene, and other NMVOCs. We calculated total ocean dry deposition of 10.8 MtC yr^{-1} and wet deposition of 39.1 MtC yr^{-1} , which together account for around 27% of total surface deposition (with 73% assumed to occur over land). Some of these intermediate products have short lifetimes and are, therefore, mainly deposited close to their [pointpoints](#) of production, which is mostly over land areas.

Summing these various fluxes provides an additional $\sim 50 \text{ MtC yr}^{-1}$ of non- CO_2 flux from the atmosphere to the oceans. Any [estimationestimate](#) of global fluxes depends strongly on deposition schemes, chemical mechanisms, and terrestrial NMVOC emissions, which vary among global models and are poorly constrained by observations. Hence, there are considerable uncertainties in these estimated fluxes, as demonstrated by Jacob et al. (2005), for example, in the case of the global methanol budget. They summarised the results of various previous studies and reported global dry deposition on the oceans estimated by different models of $0.3\text{--}50 \text{ Mt}(\text{CH}_3\text{OH}) \text{ yr}^{-1}$ plus total global wet deposition of $9\text{--}50 \text{ Mt}(\text{CH}_3\text{OH}) \text{ yr}^{-1}$ [without separationwhich was not separated](#) between land and ocean deposition.

This illustrates the remaining level of uncertainties in these global estimates. There are also considerable differences in isoprene and monoterpene oxidation mechanisms among the models, in particular, the formation of intermediate products from isoprene oxidation (e.g. Paulot et al., 2009). Some further information on these uncertainties is given in on-line Supplemental Information.

10. Summary of the Main Fluxes in the Global Carbon Cycle

Consideration of these additional pools and fluxes reduces the estimated additional carbon stored in the terrestrial biosphere, ΔB_{phys} , from 3.6 to $2.1\text{--}9 \text{ GtC yr}^{-1}$ (Fig. 7, Table 4). While none of the various extra fluxes are particularly large or important on their own, added together, they [reducedreduce](#) the size of the inferred terrestrial biosphere sink by about 1.5 GtC yr^{-1} .

For greater transparency, it would also be desirable to explicitly include harvested-wood products and landfill pools. The associated carbon flux is already included under the net-land-use calculations (Le Quere et al., 2018). Inclusion of a harvested-wood-products pool, therefore, would not affect the size of the residual sink, but it would require a corresponding adjustment of the net land-use-change flux.

The fluxes into increasing pools of plastics, bitumen, and waste storage in landfills are clear and obvious fluxes that are quantitatively important and additional to fluxes currently considered by Le Quere et al. (2018). Their effect on the overall budget had, however, also already been included indirectly in the fossil-fuel fluxes through a term that accounts for incomplete oxidation of fossil fuel use (Marland and Rotty, 1984). The fluxes into the increasing pools of plastic and bitumen are reasonably well constrained. The flux into increasing landfill carbon storage is less well constrained, as we could find no prior global assessment of this flux. We have provided a first such global estimate in

the present work, but significant uncertainty remains due to incomplete knowledge of regional details of the key properties of different waste streams. In any case, explicit inclusion of fluxes into these storage pools would be desirable to increase transparency of the overall global carbon budget.

5 These incomplete oxidation terms for fossil-fuel use (Marland and Rotty, 1984) account for incomplete combustion during energy generation and for non-fuel uses. That has been represented explicitly in Figure 7. For internal consistency, the fossil-fuel consumption rates have therefore been increased by 0.4 GtC yr^{-1} so that non-fuel uses are given explicitly in Figure 7. While for transparency, it would be desirable to make these fluxes explicit, it would not affect the estimated size of the residual sink.

10 Cement carbonation is an additional sink that is likely to increase in proportion to the cumulative total amount of manufactured cement and is, therefore, likely to increase further into the future. Its magnitude is also reasonably well constrained and is clearly bounded by the total historical cement production. This flux has so far been omitted from the global carbon budget, and its inclusion reduces the size of the residual sink.

15 River transport as dissolved and particulate organic carbon is also reasonably well constrained. ~~However, even though~~ the enormous heterogeneity of river types makes confident assessment difficult. This is further compounded by the disproportionate importance of rare flooding events that can episodically transport large quantities of particulate organic matter. Nonetheless, the various global estimates are converging on similar flux estimates (e.g. Regnier et al., 2013; Drake et al., 2018).

20 A fraction of this organic carbon flux is oxidised in the shallow ocean, leading to outgassing in some regions (e.g. Borges et al., 2005; Jacobson et al., 2007). Another fraction is transferred to the ocean floor or the deep ocean in organic form. Particulate organic carbon associated with soil minerals is particularly prone to direct sinking to the ocean floor. That mineral-associated fraction should obviously be included. The fraction that is oxidised in the shallow ocean and converted to inorganic carbon will increase the surface $p\text{CO}_2$ (partial pressure of CO_2). This lowers the atmosphere to ocean CO_2 gradient and reduces ocean CO_2 uptake, or can even lead to outgassing. Calculations of ocean CO_2 uptake by gaseous exchange ~~should~~ ~~could be~~ correctly ~~reflect that estimated without bias~~, but total transfer of CO_2 to the surface ocean will be the combined flux of air–sea exchange plus the additional contribution of organic carbon that found its way to the ocean by aeolian or river transfer, or by gas transfer of non- CO_2 carbon compounds. Regardless of those further transformations, Figure 2 showed that it would be appropriate to include this flux of organic carbon as an important addition to the overall budget.

30 Deposition of carbon in inland ~~water-ways~~ ~~waterways~~ is another quantitatively important flux into an additional carbon storage pool that should be included in the overall budget. With the increasing regulation of ~~water-ways~~ ~~waterways~~ and the construction of more dams on the world's rivers (e.g. Regnier et al., 2013), and possible increases in erosion fluxes (e.g. Yang et al., 2003), this flux is also likely to continue to increase into the future.

35 Some of the erosion-related component of this flux constitutes a simple lateral carbon transfer from erosion sites to some downstream ~~water-way~~ ~~waterways~~ with no net effect on the atmosphere. However, most denuded erosion sites can eventually regain their lost soil organic carbon. While that process is slow and may remain incomplete, the resultant potential carbon gain needs to also be factored in (van Oost et al., 2007). It would, therefore, be too simplistic to ignore inland deposition as just a lateral transfer. In its totality, erosion may act as a net sink or source of carbon to the atmosphere. For global carbon accounting purposes, it means that inland deposition should be included, but any changes in soil carbon stocks also need to be quantified to complete the overall balance.

The next relevant flux is the transport of carbon attached to aeolian dust or charcoal. Again, this flux transfers carbon from the land surface to the oceans through means that are not quantified through CO₂ exchange at the air-surface interchange. This flux may contribute an additional 50-100 MtC yr⁻¹. Finally, methane, NMVOCs, and their intermediate oxidation products can be transferred directly to the oceans. As with river and aeolian transport, the subsequent fate of these products after they reach the oceans does not change their important role as a carbon-transfer mechanism, and, therefore, these fluxes should be included. Here, we have provided a first global estimate of the size of these combined fluxes of about 50 MtC yr⁻¹.

The sizes of these various fluxes have been estimated in previous publications that have focused on one process or another, or they have been calculated here based on existing underlying information where no prior global estimates could be found. The novel contribution of the present analysis is bringing these fluxes together in a combined assessment (Fig. 7), which has not previously been done. While the exact magnitude of some of these fluxes remains uncertain, it is clear that they are not zero. Their exclusion from past global carbon budgets has, therefore, systematically inflated the size of the estimated $\Delta B \Delta B_{\text{phys}}$. It is, therefore, warranted to include them in future budgets and move towards a better, and less biased, estimate of $\Delta B \Delta B_{\text{phys}}$ and the residual sink strength of the terrestrial biosphere.

11. Implications for biosphere models

The residual sink is often implicitly or explicitly equated with net exchange by the biosphere, with the two flux estimates even presented on the same graph by Ciais et al. (2013), and Le Quere et al. (2018) have referred to the residual sink as the ‘land sink’. The size of the residual sink has thus been used as an important reality check of the structure and parameterisation of existing biosphere models.

However, equating the residual sink to $\Delta B \Delta B_{\text{phys}}$ without accounting for these additional fluxes has led to an overestimation of $\Delta B \Delta B_{\text{phys}}$ with important implications for our assessment of the veracity of existing biosphere models (Fig. 8). Taking the annual flux estimates generated by the average of accepted biosphere models and the size of the originally calculated residual sink, one obtains a fairly good relationship, with estimates largely conforming to a 1:1 relationship (Fig. 8a).

If one expresses the flux estimates of the biosphere models against the revised estimates of $\Delta B \Delta B_{\text{phys}}$, however, the match against the 1:1 line is poor. There is a large discrepancy, with the biosphere models estimating sink activity that is about 1.0–1.5 GtC yr⁻¹ higher than the corresponding estimates of the revised residual sink activity (Fig. 8b). This suggests that current biosphere models systematically overestimate biospheric carbon uptake, which has important implications for present-day overall global carbon fluxes. It suggests that biosphere models may similarly overpredict future carbon uptake rates. If enhanced carbon uptake by the terrestrial biosphere in response to climate change, including increasing atmospheric CO₂, is overestimated, it will similarly overestimate the extent by which biospheric feedbacks could negate future anthropogenic greenhouse gas emissions.

12. General Discussion

An understanding of the global carbon cycle is important for a full appreciation of the anthropogenic disturbance of the cycle, and to what extent that disturbance is negated, or amplified, through natural feedback processes. It is even more important for a guide to the magnitude of future feedback processes (e.g. Cramer et al., 2001;

Friedlingstein et al., 2006; Jones et al., 2013; Huntzinger et al., 2017). It is important to anticipate whether any current carbon uptake by the biosphere may be reversed under future climatic conditions, especially under ongoing and intensifying warming (e.g. Kirschbaum, 2000), while plants may become less responsive to CO₂ as atmospheric concentrations trend towards CO₂ saturation (e.g. Friedlingstein et al., 2006).

5 The comparisons between the residual sink and biospheric net CO₂ uptake have been given explicitly by the IPCC (Ciais et al., 2013), and they play an important role as a reality check of global biosphere models (e.g. Arneeth et al., 2017; Huntzinger et al., 2017). However, to fulfil that role, it is essential that the comparisons use comparable numbers. It is therefore important to calculate ΔB_{phys} after the various known terms listed above have been explicitly quantified and subtracted from the 'residual sink'.

10 To anticipate correctly whether future natural biospheric carbon exchange will add to or subtract from anthropogenic emissions, it is essential to assign sink activity to the appropriate processes. If sink activity is assumed to relate to net uptake by the biosphere, one might expect it to respond to factors such as the age class distribution of forests, or temperature, precipitation, CO₂ concentration, or land management, ~~especially to the age class of forests.~~ If one ~~correctly~~incorrectly infers the sensitivity of the system to these external factors, it is ~~possible~~would be impossible to predict future ~~biosphere~~biospheric responses.

15 ~~However, the~~The various factors identified above respond to different drivers. Aeolian fluxes, for example, ~~are probably fairly constant from year to year, or might~~ respond to climate variability like the ENSO cycle and longer-term land-use and management choices, and fluxes related to the oxidation of methane and NMVOCs would be proportional to the underlying fluxes of methane and NMVOCs. Storage in increasing pools of plastic, bitumen and landfills, as well as cement carbonation are clearly determined by anthropogenic factors, such as economic and technological development. Future fluxes, therefore, will not respond to future temperature or CO₂ concentration, but need to be assessed through assessment of socio-economic developments.

20 Terrestrial net carbon exchange can be further sub-divided into at least four distinct processes:

12.1. Growth rate changes related to forest age.

25 Forest growth tends to be highest in young stands and ~~decreases~~decreases as stands age (Ryan et al., 1997; Kurz and Apps, 1999). Any net forest growth can therefore be due to the rebound of forest biomass ~~in response to prior disturbance through harvesting or natural processes such as wildfire (e.g. after prior disturbance through anthropogenic or natural processes.~~ Stinson et al., 2011). ~~Many of the world's forests are now being inventoried at regular intervals (Pan et al., 2011) which can be supplemented with remotely sensed information (Dong et al., 2003).~~

30 ~~Growth responses can be inferred from these changes in age class distribution (Stinson et al., 2011).~~

~~Any net carbon uptake by forests is likely to be largely due to their disturbance history.~~ Disturbance may be through the harvesting of established forests or the planting of new ones, or due to natural factors, such as wildfire or insect-pest outbreaks (e.g. Stinson et al., 2011). The presence of a global net forest sink implies that ~~the rate of~~ new growth exceeds ~~the losses~~ through wood extraction and other disturbance factors. A forest sink can be caused by disturbance-related carbon losses in preceding years. Understanding forest growth under current and future conditions therefore requires disturbance effects and age-class distributions to be combined with an assessment of biophysical growth factors (e.g. Chen et al., 2000). ~~Many of the world's forests are now being inventoried at regular intervals (Pan et al., 2011) which can be supplemented with remotely sensed information (Dong et al., 2003).~~ Growth responses can

be inferred from these changes in age-class distribution (Stinson et al., 2011), although subtler disturbance related effects on woody biomass are difficult to capture fully at the global scale and may have led to past underestimation of land-use change related carbon emissions (Arneeth et al. 2017), with a consequent larger rebound potential as well.

12.2. Growth rate changes related to biophysical drivers.

5 In principle, growth can be enhanced by increasing CO₂ concentrations (Pugh et al., 2016; Hickler et al., 2015), nitrogen deposition from industrial pollution (LeBauer and Treseder, 2008), or climatic changes apart from increasing CO₂ concentrations, such as by increasing temperatures (Reyer, 2015; Sitch et al., 2015). Most modelling work has focused on these drivers as they can most easily be generalised and predicted into the future, but their actual importance is remains uncertain (Arneeth et al., 2017; Huntzinger et al., 2017), especially in relation to age-class effects of forests that might be the principal driver of any change in the sink-source balance of forests as discussed under the previous point. It is also likely that forests subject to nutrient limitations are less responsive to changes in other biophysical drivers (e.g. Kirschbaum et al., 1998; Norby et al., 2010; Huntzinger et al., 2017) as nutrient availability retains an over-riding importance for stand productivity.

12.3. Blue carbon.

15 It has recently been recognised that mangrove forests, seagrass beds and salt marshes, can sequester large amounts of carbon, recently termed 'blue carbon' (McLeod et al., 2011; Huxham et al., 2018). It has been estimated to constitute a global carbon sink of about at least 200 MtC yr⁻¹ (McLeod et al., 2011) or even more (Breithaupt et al., 2012). However, infrastructure development of coastal habitats for human infrastructure not only prevents ongoing carbon sequestration by these ecosystems but can also lead to the release of the large carbon stocks of these systems. Overall, that such development may result in comparable annual carbon losses as the ongoing sequestration by intact systems (e.g. Pendleton et al., 2012; Regnier et al., 2013; Atwood et al., 2017).

12.4. Soil organic carbon.

There may also be changes in soil carbon that can be very difficult to detect. Globally, there are about 2,500 GtC in soil organic matter to a depth of 2 m (Batjes, 2004) so that a change by just 0.4% yr⁻¹ would equate to a flux of 10 GtC yr⁻¹ to or from the atmosphere (Minasny et al., 2017). Such a change could be readily associated with land-use changes (e.g. Guo and Gifford, 2002; Kim and Kirschbaum, 2015). They may also correspond to episodic changes within given land uses, especially changes related to accelerated erosion under agricultural land use (e.g. van Oost et al., 2007; Quinton et al., 2010; de Rose, 2013).

Observational verification of annual changes of the order of 0.4% yr⁻¹ is extremely difficult owing to the many important factors that may positively or negatively affect soil carbon levels under different circumstances and over different time scales (e.g. Schipper et al., 2017). However, even such proportionately small changes could be very important in the global budget and have become the basis of the recent 4 per mille initiative (e.g. Minasny et al., 2017) which aims to promote land-use practices to increase soil carbon by that amount.

13. Conclusions

It is important to ensure that anthropogenic CO₂ emissions do not lead to changes in atmospheric CO₂ concentrations with dangerous consequences for nature and society. A good understanding of the global carbon budget is essential for a good assessment of current and likely future trends in carbon stocks and fluxes. However, the global carbon budget in its currently used ~~form is overly simplified~~ ~~form is incomplete~~ and, therefore, does not provide appropriate guidance on the way anthropogenic and natural processes interact to lead to the observed increases in atmospheric concentrations. ~~It also does not provide sufficient detail of some important component fluxes which hinders a full appreciation of their role in the global budget.~~ These simplifications warrant modifications to the budget to explicitly and comprehensively include other known carbon fluxes between major carbon pools. While the magnitude of these various fluxes remains uncertain, understanding of the key processes has grown over the years so that it has become appropriate for these additional fluxes to be explicitly included in future global budgets.

The greatest practical importance of that inclusion lies in the role of the global budget as a reality check for the development and parameterisation of global biosphere models. Past omission of the various known but omitted carbon fluxes discussed here is likely to have inflated the estimated sizes of natural sink activity. To provide a truer guide for the role and magnitude of these natural fluxes, it is warranted to provide a revised and more detailed assessment of the most likely changes in biospheric carbon stocks. The Global Carbon Budget is a key analysis tool for understanding the anthropogenic effect on disturbing that budget. ~~As such, it plays a key role in informing the global research and such-policy-making community on trends in carbon dynamics, and~~ ongoing refinement is warranted and necessary to ~~fully fulfil that important role.~~

14. Acknowledgments

We would like to thank Robbie Andrew, Pep Canadell, Andrew McMillan, Sara Mikaloff-Fletcher and ~~and~~ ~~different~~ anonymous ~~refereereviewers~~ for useful contributions to the underlying concepts discussed here, particularly, on the details of some of the calculations embedded in the annual carbon budget published by the Global Carbon Project, and for providing specific comments on the manuscript. We would also like to thank Anne Austin for scientific editing.

We acknowledge funding by the NZ Government's Strategic Science Investment Fund (SSIF), the UK Met Office for use of the MetUM, and the contribution of NeSI high-performance computing facilities funded jointly by NeSI's collaborator institutions and New Zealand's MBIE's Research Infrastructure programme (<https://www.nesi.org.nz>).

15. References

Andres, R.J., Boden, T.A., Breon, F.M., Ciais, P., Davis, S., Erickson, D., Gregg, J.S., Jacobson, A., Marland, G., Miller, J., Oda, T., Olivier, J.G.J., Raupach, M.R., Rayner, P., and Treanton, K.: A synthesis of carbon dioxide emissions from fossil-fuel combustion. *Biogeosciences*, 9, 1845–1871, 2012.

Andrew, R.M.: Global CO₂ emissions from cement production. *Earth Syst. Sci. Data*, 10, 195–217, 2018.

Armeth, A., Sitch, S., Pongratz, J., Stocker, B.D., Ciais, P., Poulter, B., Bayer, A.D., Bondeau, A., Calle, L., Chini, L.P.,

Gasser, T., Fader, M., Friedlingstein, P., Kato, E., Li, W., Lindeskog, M., Nabel, J.E.M.S., Pugh, T.A.M., Robertson, E.,

- Viovy, N., Yue, C., and Zaehle, S.: Historical carbon dioxide emissions caused by land-use changes are possibly larger than assumed. *Nat. Geosci.*, 10, 79–86, 2017.
- Atwood, T.B., Connolly, R.M., Almahasheer, H., Carnell, P.E., Duarte, C.M., Lewis, C.J.E., Irigoien, X., Kelleway, J.J., Lavery, P.S., Macreadie, P.I., Serrano, O., Sanders, C.J., Santos, I., Steven, A.D.L., and Lovelock, C.E.: Global patterns in mangrove soil carbon stocks and losses. *Nat. Clim. Change*, 7, 523–529, 2017.
- Aufdenkampe, A.K., Mayorga, E., Raymond, P.A., Melack, J.M., Doney, S.C., Alin, S.R., Aalto, R.E., and Yoo, K.: Riverine coupling of biogeochemical cycles between land, oceans, and atmosphere. *Front. Ecol. Environ.*, 9, 53–60, 2011.
- Barlaz, M.A.: Forest products decomposition in municipal solid waste landfills. *Waste Manage.*, 26, 321–333, 2006.
- Batjes, N.H.: Total carbon and nitrogen in the soils of the world. *Eur. J. Soil Sci.*, 65, 10–21, 2004.
- 10 Borges, A.V., Delille, B., and Frankignoulle, M.: Budgeting sinks and sources of CO₂ in the coastal ocean: Diversity of ecosystems counts. *Geophys. Res. Lett.*, 32, 1–4, 2005.
- Breithaupt, J.L., Smoak, J.M., Smith, T.J., Sanders, C.J., and Hoare, A.: Organic carbon burial rates in mangrove sediments: Strengthening the global budget. *Global Biogeochem. Cycles*, 26, Article Number: GB3011, 2012.
- Brunet-Navarro, P., Jochheim, H., and Muys, B.: Modelling carbon stocks and fluxes in the wood product sector: a comparative review. *Global Change Biol.*, 22, 2555–2569, 2016.
- 15 Ciais, P., Sabine, C., Bala, G., Bopp, L., Brovkin, V., Canadell, J., Chhabra, A., DeFries, R., Galloway, J., Heimann, M., Jones, C., Le Quéré, C., Myneni, R.B., Piao, S., and Thornton, P.: Carbon and Other Biogeochemical Cycles. In: Stocker, T.F., Qin, D., Plattner, G.-K., Tignor, M., Allen, S.K., Boschung, J., Nauels, A., Xia, Y., Bex V., and Midgley, P.M. (Eds.), *Climate Change 2013: The Physical Science Basis. Contribution of Working Group I to the Fifth Assessment Report of the Intergovernmental Panel on Climate Change*. Cambridge University Press, Cambridge, United Kingdom and New York, NY, USA, pp. 465–570, 2013.
- 20 Chappell, A., Webb, N.P., Butler, H.J., Strong, C.L., McTainsh, G.H., Leys, J.F., and Rossel, R.A.V.: Soil organic carbon dust emission: an omitted global source of atmospheric CO₂. *Global Change Biol.*, 19, 3238–3244, 2013.
- Chen, J., Chen, W.J., Liu, J., Cihlar, J., and Gray, S.: Annual carbon balance of Canada's forests during 1895-1996. *Global Biogeochem. Cycles*, 14, 839–849, 2000.
- 25 Cole, J.J., Prairie, Y.T., Caraco, N.F., McDowell, W.H., Tranvik, L.J., Striegl, R.G., Duarte, C.M., Kortelainen, P., Downing, J.A., Middelburg, J.J., Melack, J.: Plumbing the global carbon cycle: Integrating inland waters into the terrestrial carbon budget. *Ecosystems*, 10, 171–184, 2007.
- Cramer, W., Bondeau, A., Woodward, F.I., Prentice, I.C., Betts, R.A., Brovkin, V., Cox, P.M., Fisher, V., Foley, J.A., Friend, A.D., Kucharik, C., Lomas, M.R., Ramankutty, N., Sitch, S., Smith, B., White, A., and Young-Molling, C.: Global response of terrestrial ecosystem structure and function to CO₂ and climate change: results from six dynamic global vegetation models. *Global Change Biol.*, 7, 357–373, 2001.
- 30 De Rose, R.C.: Slope control on the frequency distribution of shallow landslides and associated soil properties, North Island, New Zealand. *Earth Surf. Processes Landforms*, 38, 356–371, 2013.

- Dong, J.R., Kaufmann, R.K., Myneni, R.B., Tucker, C.J., Kauppi, P.E., Liski, J., Buermann, W., Alexeyev, V., and Hughes, M.K.: Remote sensing estimates of boreal and temperate forest woody biomass: carbon pools, sources, and sinks. *Remote Sens. Environ.*, 84, 393–410, 2003.
- Drake, T.W., Raymond, P.A., and Spencer, R.G.M.: Terrestrial carbon inputs to inland waters: A current synthesis of estimates and uncertainty. *Limnol. Oceanogr. Lett.*, 3, 132–142, 2018.
- 5
- FAO: FAOSTAT-Forestry Database [online]. Food and Agriculture Organization (FAO) of the United Nations. <http://www.fao.org/forestry/statistics/en/>. 2016.
- Forbes, M.S., Raison, R.J., and Skjemstad, J.O.: Formation, transformation and transport of black carbon (charcoal) in terrestrial and aquatic ecosystems. *Sci. Total Environ.*, 370, 190–206, 2006.
- 10
- Fowler, D., Pilegaard, K., Sutton, M.A., et al.: Atmospheric composition change: Ecosystems–Atmosphere interactions. *Atmos. Environ.*, 43, 5193–5267, 2009.
- Friedlingstein, P., Cox, P., Betts, R., Bopp, L., Von Bloh, W., Brovkin, V., Cadule, P., Doney, S., Eby, M., Fung, I., Bala, G., John, J., Jones, C., Joos, F., Kato, T., Kawamiya, M., Knorr, W., Lindsay, K., Matthews, H.D., Raddatz, T., Rayner, P., Reick, C., Roeckner, E., Schnitzler, K.G., Schnur, R., Strassmann, K., Weaver, A.J., Yoshikawa, C., and Zeng, N.: Climate-carbon cycle feedback analysis: Results from the C⁴MIP model intercomparison. *J. Clim.*, 19, 3337–3353, 2006.
- 15
- Guo, L.B. and Gifford, R.M.: Soil carbon stocks and land use change: a meta analysis. *Global Change Biol.*, 8, 345–360, 2002.
- Hickler, T., Rammig, A., and Werner, C.: Modelling CO₂ impacts on forest productivity. *Curr. Forestry Rep.*, 1, 69–80, 2015.
- 20
- Hoornweg, D. and Bhada-Tata, P.: What a Waste. A Global Review of Solid Waste Management. Urban Development Series Knowledge Papers. March 2012, No. 15. The World Bank, 98 pp., 2012.
- Huntzinger, D.N., Michalak, A.M., Schwalm, C., Ciais, P., King, A.W., Fang, Y., Schaefer, K., Wei, Y., Cook, R.B., Fisher, J.B., Hayes, D., Huang, M., Ito, A., Jain, A.K., Lei, H., Lu, C., Maignan, F., Mao, J., Parazoo, N., Peng, S., Poulter, B., Ricciuto, D., Shi, X., Tian, H., Wang, W., Zeng, N., and Zhao, F.: Uncertainty in the response of terrestrial carbon sink to environmental drivers undermines carbon-climate feedback predictions. *Sci. Rep.* 7, Article #4765, 2017.
- 25
- Huxham, M., Whitlock, D., Githaiga, M., and Dencer-Brown, A.: Carbon in the coastal seascape: how interactions between mangrove forests, seagrass meadows and tidal marshes influence carbon storage. *Curr. Forestry Rep.*, 4, 101–110, 2018.
- 30
- IPCC: 2006 IPCC Guidelines for National Greenhouse Gas Inventories, Prepared by the National Greenhouse Gas Inventories Programme, Eggleston, H.S., Buendia, L., Miwa, K., Ngara, T., and Tanabe, K. (Eds). Published: IGES, Japan, 2006.
- IPCC: Section 2.8. Harvested Wood Products. In: Hiraishi, T., Krug, T., Tanabe, K., Srivastava, N., Baasansuren, J., Fukuda, M., and Troxler, T.G. (Eds), 2013 Revised Supplementary Methods and Good Practice Guidance Arising from the Kyoto Protocol, Published: IPCC, Switzerland, 2014.
- 35

- Jacob, D.J., Field, B.D., Li, Q., Blake, D.R., de Gouw, J., Warneke, C., Hansel, A., Wisthaler, A., Singh, H.B., and Guenther, A.: Global budget of methanol: Constraints from atmospheric observations. *J. Geophys. Res.*, 110, Article DO8303, 2005.
- Jacobson, A.R., Mikaloff Fletcher, S.E., Gruber, N., Sarmiento, J.L., and Gloor, M.: A joint atmosphere-ocean inversion for surface fluxes of carbon dioxide: 1. Methods and global-scale fluxes. *Global Biogeochem. Cycles*, 21, Article GB1019, 2007.
- Jones, C., Robertson, E., Arora, V., Friedlingstein, P., Shevliakova, E., Bopp, L., Brovkin, V., Hajima, T., Kato, E., Kawamiya, M., Liddicoat, S., Lindsay, K., Reick, C.H., Roelandt, C., Segsneider, J., and Tjiputra, J.: Twenty-first-century compatible CO₂ emissions and airborne fraction simulated by CMIP5 earth system models under four Representative Concentration Pathways. *J. Clim.*, 26, 4398–4413, 2013.
- Kayo, C., Oka, H., Hashimoto, S., Mizukami, M., and Takagi, S.: Socioeconomic development and wood consumption. *J. For. Res.*, 20, 309–320, 2015.
- Kim, D.-G. and Kirschbaum, M.U.F.: The effect of land-use change on the net exchange rates of greenhouse gases: a compilation of prior estimates. *Agric. Ecosyst. Environ.*, 208, 114–126, 2015.
- Kirschbaum, M.U.F.: Will changes in soil organic matter act as a positive or negative feedback on global warming? *Biogeochemistry*, 48, 21–51, 2000.
- Kirschbaum, M.U.F., Medlyn, B.E., King, D.A., Pongracic, S., Murty, D., Keith, H., Khanna, P.K., Snowdon, P., and Raison, J.R.: Modelling forest-growth response to increasing CO₂ concentration in relation to various factors affecting nutrient supply. *Global Change Biol.*, 4, 23–42, 1998.
- Kirschke, S., Bousquet, P., Ciais, P., et al.: Three decades of global methane sources and sinks. *Nat. Geosci.*, 6, 813–823, 2013.
- Kuhlbusch, T.A.J. and Crutzen, P.J.: Toward a global estimate of black carbon in residues of vegetation fires representing a sink of atmospheric. *Global Biogeochem. Cycles*, 9, 491–501, 1995.
- Kurz, W.A. and Apps, M.J.: A 70-year retrospective analysis of carbon fluxes in the Canadian forest sector. *Ecol. Appl.*, 9, 526–547, 1999.
- Lauk, C., Haberl, H., Erb, K.H., Gingrich, S., and Krausmann, F.: Global socioeconomic carbon stocks in long-lived products 1900–2008. *Environ. Res. Lett.*, 7, Article Number: 034023, 2012.
- LeBauer, D.S. and Treseder, K.K.: Nitrogen limitation of net primary productivity in terrestrial ecosystems is globally distributed. *Ecology*, 89, 371–379, 2008.
- Le Quere, C., Andrew, R.M., Friedlingstein, P., et al.: Global Carbon Budget 2017. *Earth Syst. Sci. Data*, 10, 405–448, 2018.
- Le Quere, C., Andrew, R.M., Canadell, J.G., et al.: Global Carbon Budget 2016. *Earth Syst. Sci. Data*, 8, 605–649, 2016.
- Mahowald, N.M., Baker, A.R., Bergametti, G., Brooks, N., Duce, R.A., Jickells, T.D., Kubilay, N., Prospero, J.M., and Tegen, I.: Atmospheric global dust cycle and iron inputs to the ocean. *Global Biogeochem. Cycles*, 19, Article Number: GB4025, 2005.

- Marland, G. and Rotty, R.M.: Carbon dioxide emissions from fossil fuels: a procedure for estimation and results for 1950–1982. *Tellus* 36B: 232–261, 1984.
- McLeod, E., Chmura, G.L., Bouillon, S., Salm, R., Bjork, M., Duarte, C.M., Lovelock, C.E., Schlesinger, W.H., and Silliman, B.R.: A blueprint for blue carbon: toward an improved understanding of the role of vegetated coastal habitats in sequestering CO₂. *Front. Ecol. Environ.*, 9, 552–560, 2011.
- Mendonca, R., Muller, R.A., Clow, D., Verpoorter, C., Raymond, P., Tranvik, L.J., and Sobek, S.: Organic carbon burial in global lakes and reservoirs. *Nat. Commun.*, 8, Article Number: 1694, 2017.
- Minasny, B., Malone, B.P., McBratney, A.B., et al.: Soil carbon 4 per mille. *Geoderma*, 292, 59–86, 2017.
- Norby, R.J., Warren, J.M., Iversen, C.M., Medlyn, B.E., and McMurtrie, R.E.: CO₂ enhancement of forest productivity constrained by limited nitrogen availability. *PNAS*, 107, 19368–19373, 2010.
- Pan, Y.D., Birdsey, R.A., Fang, J.Y., Houghton, R., Kauppi, P.E., Kurz, W.A., Phillips, O.L., Shvidenko, A., Lewis, S.L., Canadell, J.G., Ciais, P., Jackson, R.B., Pacala, S.W., McGuire, A.D., Piao, S.L., Rautiainen, A., Sitch, S., and Hayes, D.: A large and persistent carbon sink in the World's forests. *Science*, 333, 988–993, 2011.
- Paulot, F., Crounse, J.D., Kjaergaard, H.G., Kurten, A., St Clair, J.M., Seinfeld, J.H., and Wennberg, P.O.: Unexpected epoxide formation in the gas-phase photooxidation of isoprene. *Science*, 325, 730–733, 2009.
- Prognos: European Atlas of Secondary Raw Materials. 2004 Status Quo and Potentials. Prognos AG, 17 pp, 2008.
- Pugh, T.A.M., Muller, C., Arneeth, A., Haverd, V., and Smith, B.: Key knowledge and data gaps in modelling the influence of CO₂ concentration on the terrestrial carbon sink. *J. Plant Physiol.*, 203, 3–15, 2016.
- Pendleton, L., Donato, D.C., Murray, B.C., Crooks, S., Jenkins, W.A., Sifleet, S., Craft, C., Fourqurean, J.W., Kauffman, J.B., Marba, N., Megonigal, P., Pidgeon, E., Herr, D., Gordon, D., and Baldera, A.: Estimating global “Blue Carbon” emissions from conversion and degradation of vegetated coastal ecosystems. *PLOS One*, 7, Article Number: e43542, 2012.
- Quinton, J.N., Govers, G., Van Oost, K., Bardgett, R.D.: The impact of agricultural soil erosion on biogeochemical cycling. *Nat. Geosci.*, 3, 311–314, 2010.
- Raymond, P.A., Hartmann, J., Lauerwald, R., Sobek, S., McDonald, C., Hoover, M., Butman, D., Striegl, R., Mayorga, E., Humborg, C., Kortelainen, P., Durr, H., Meybeck, M., Ciais, P., Guth, P.: Global carbon dioxide emissions from inland waters. *Nature*, 503, 355–359, 2013.
- Regnier, P., Friedlingstein, P., Ciais, P., Mackenzie, F.T., Gruber, N., Janssens, I.A., Laruelle, G.G., Lauerwald, R., Luyssaert, S., Andersson, A.J., Arndt, S., Arnosti, C., Borges, A.V., Dale, A.W., Gallego-Sala, A., Godderis, Y., Goossens, N., Hartmann, J., Heinze, C., Ilyina, T., Joos, F., LaRowe, D.E., Leifeld, J., Meysman, F.J.R., Munhoven, G., Raymond, P.A., Spahni, R., Suntharalingam, P., and Thullner, M.: Anthropogenic perturbation of the carbon fluxes from land to ocean. *Nat. Geosci.*, 6, 597–607, 2013.
- Reyer, C.: Forest productivity under environmental change: A review of stand-scale modeling studies. *Curr. Forestry Rep.*, 1, 53–68, 2015.

- Richey, J.E.: Pathways of atmospheric CO₂ through fluvial systems. In: Field, C.B. and Raupach, M.R. (Eds.), *The global carbon cycle. Integrating humans, climate, and the natural world*, Scope 62, Island Press, Washington, pp. 329–340, 2004.
- Romankevich, E.A.: *Geochemistry of Organic Matter in the Ocean*. Springer, Berlin a.o., XV + 334 pp., 1984.
- 5 Romankevich, E.A., Vetrov, A.A., and Peresykin, V.I.: Organic matter of the World Ocean. *Russ. Geol. Geophys.*, 50, 299–307, 2009.
- Ryan, M.G., Binkley, D., and Fownes, J.H.: Age-related decline in forest productivity: Pattern and process. *Adv. Ecol. Res.*, 27, 213–262, 1997.
- Schipper, L.A., Mudge, P.L., Kirschbaum, M.U.F., Hedley, C.B., Golubiewski, N.E., Smaill, S.J., and Kelliher, F.M.:
10 A review of soil carbon change in grazed New Zealand pastures. *N. Z. J. Agric. Res.*, 60, 93–118, 2017.
- Schlünz, B. and Schneider, R.R.: Transport of terrestrial organic carbon to the oceans by rivers: re-estimating flux- and burial rates. *Int. J. Earth Sci.*, 88, 599–606, 2000.
- Seitzinger, S.P., Harrison, J.A., Dumont, E., Beusen, A.H.W., and Bouwman, A.F.: Sources and delivery of carbon, nitrogen, and phosphorus to the coastal zone: An overview of Global Nutrient Export from Watersheds (NEWS)
15 models and their application. *Global Biogeochem. Cycles*, 19, Article Number: GB4S01, 2005.
- Sitch, S., Friedlingstein, P., Gruber, N., Jones, S.D., Murray-Tortarolo, G., Ahlstrom, A., Doney, S.C., Graven, H., Heinze, C., Huntingford, C., Levis, S., Levy, P.E., Lomas, M., Poulter, B., Viovy, N., Zaehle, S., Zeng, N., Arneth, A., Bonan, G., Bopp, L., Canadell, J.G., Chevallier, F., Ciais, P., Ellis, R., Gloor, M., Peylin, P., Piao, S.L., Le Quere, C., Smith, B., Zhu, Z., and Myneni, R.: Recent trends and drivers of regional sources and sinks of carbon dioxide
20 *Biogeosciences*, 12, 653–679, 2015.
- Stallard, R.F.: Terrestrial sedimentation and the carbon cycle: Coupling weathering and erosion to carbon burial. *Global Biogeochem. Cycles*, 12, 231–257, 1998.
- Stinson, G., Kurz, W.A., Smyth, C.E., Neilson, E.T., Dymond, C.C., Metsaranta, J.M., Boisvenue, C., Rampley, G.J., Li, Q., White, T.M., and Blain, D.: An inventory-based analysis of Canada's managed forest carbon dynamics, 1990
25 to 2008. *Global Change Biol.*, 17, 2227–2244, 2011.
- Tranvik, L.J., Downing, J.A., Cotner, J.B., et al.: Lakes and reservoirs as regulators of carbon cycling and climate. *Limnol. Oceanogr.*, 54, 2298–2314, 2009.
- Van Oost, K., Quine, T.A., Govers, G., De Gryze, S., Six, J., Harden, J.W., Ritchie, J.C., McCarty, G.W., Heckrath, G., Kosmas, C., Giraldez, J.V., da Silva, J.R.M., and Merckx, R.: The impact of agricultural soil erosion on the global
30 carbon cycle. *Science*, 318, 626–629, 2007.
- Wang, X., Padgett, J.M., De la Cruz, F.B., and Barlaz, M.A.: Wood biodegradation in laboratory scale landfills. *Environ. Sci. Technol.*, 45, 6864–6871, 2011.
- Wang, X., De la Cruz, F.B., Ximenes, F., Barlaz, M.A.: Decomposition and carbon storage of selected paper products in laboratory-scale landfills. *Sci. Total Environ.*, 532, 70–79, 2015.
- 35 Ward, N.D., Bianchi, T.S., Medeiros, P.M., Seidel, M., Richey, J.E., Keil, R.G., and Sawakuchi, H.O.: Where carbon goes when water flows: carbon cycling across the aquatic continuum. *Front. Mar. Sci.*, 4, Article 7, 2017.

Webb, N.P., Chappell, A., Strong, C.L., Marx, S.K., and McTainsh, G.H.: The significance of carbon-enriched dust for global carbon accounting. *Global Change Biol.*, 18, 3275–3278, 2012.

Winjum, J.K., Brown, S., and Schlamadinger, B.: Forest harvests and wood products: sources and sinks of atmospheric carbon dioxide. *Forest Sci.*, 44, 272–284, 1998.

- 5 Xi, F.M., Davis, S.J., Ciais, P., Crawford-Brown, D., Guan, D.B., Pade, C., Shi, T.M., Syddall, M., Lv, J., Ji, L.Z., Bing, L.F., Wang, J.Y., Wei, W., Yang, K.H., Lagerblad, B., Galan, I., Andrade, C., Zhang, Y., and Liu, Z.: Substantial global carbon uptake by cement carbonation. *Nat. Geosci.*, 9, 880–883, 2016.

Ximenes, F., Björdal, C., Cowie, A., and Barlaz, M.: The decay of wood in landfills in contrasting climates in Australia. *Waste Manage.*, 41, 101–110, 2015.

- 10 Ximenes, F., Cowie, A., and Barlaz, M.: The decay of engineered wood products and paper excavated from landfills in Australia. *Waste Manage.* 74, 312–322, 2018.

[Ximenes, F.A., Björdal, C., Kathuria, A., Barlaz, M.A. and Cowie, A.L.: Improving understanding of carbon storage in wood in landfills: Evidence from reactor studies. *Waste Manage.* 85, 341–350, 2019.](#)

- 15 Yang, D.W., Kanae, S., Oki, T., Koike, T., and Musiake, K.: Global potential soil erosion with reference to land use and climate changes. *Hydrol. Processes*, 17, 2913–2928, 2003.

Zender, C.S., Bian, H., and Newman, D.: Mineral dust entrainment and deposition (DEAD) model: description and 1990s dust climatology. *J. Geophys. Res.*, 108, No. D14, 4416, 2003.

Table 1: Waste generation and estimated disposal in anaerobic landfills.

Product	Estimated total disposed of in anaerobic landfills (Mt yr ⁻¹)	Dry matter (%)	Carbon fraction (%)	Carbon in long-term storage (%)	Estimated storage flux (MtC yr ⁻¹)
Wood and engineered wood products	67	89	48	98	28
Paper / paperboard	80	94	39	44	13
Plastic	57	100	75	95	41
Textile/rubber	32	82	55	40	6
Total	236				88

‘Carbon in long-term storage’ refers to the estimated proportion of waste stored permanently in anaerobic landfill sites. Total disposal estimates were derived from various sources including countries’ greenhouse gas inventories for the Waste Sector, population statistics, IPCC documents (IPCC 2006, 2014), the European Atlas of Raw Materials (Prognos, 2008) and the World Bank Waste Reports (e.g. Hoornweg and Bhada-Tata, 2012). Moisture contents were obtained from Wang et al. (2015) and Ximenes et al. (2018). Carbon fractions were taken from the IPCC Good Practice Guidance (2014), and carbon-storage factors from Wang et al. (2011, 2015) and Ximenes et al. (2018). The dry matter and carbon fractions of the wood, engineered wood products and paper/paperboard were expressed as averages weighted by global market share of the various product categories (FAO, 2016). The estimates provided here are based on the most recent available information, but were themselves based on older information largely covering the period since 2000.

Table 2: Summary of prior estimates of the main components of carbon fluxes through inland water-ways/waterways.

	€		DOC	POC	Total organic	DIC	Total river	C depos.
	Influx	efflux (evasion)						
Stallard (1998)			230	300		290		
Richey (2000)							800	
Schlünz and Schneider (2000)					434	450		
Seitzinger et al. (2005)			170	197				
Cole (2007)	1900	750				450		230
Tranvik et al. (2009)	2900	1400						600
Romankevich et al. (2009)			210	370	627*			
Aufdenkampe et al. (2011)	2700	1200					900	600
Raymond et al. (2013)		2120						
Regnier et al. (2013)		1100	200	200		400		600
Drake et al. (2018)	5100	3900						
Our estimate	2900	1400	200	250	450	450	900	600

Formatted Table

Formatted: Font: Bold

* For the total organic C flux to the ocean, in addition to DOC and POC fluxes, Romankevich et al. (2009) also estimated fluxes of 25 MtC yr⁻¹ from coastal erosion, 14 MtC yr⁻¹ from ground-water influx, and 8 MtC yr⁻¹ from glacial run-off.

Table 3: Estimated annual carbon fluxes to the world's oceans and globally (values in brackets) from dry and wet deposition of VOCs and their oxidation products to the oceans and globally (values in brackets). Data have been calculated with the NIWA-UKCA CCM model. Units are in MtC yr⁻¹

	Global dry ocean deposition	Global wet ocean deposition
Formaldehyde (HCHO)	3.4 (9.5)	11.1 (23.1)
Methyl hydroperoxide (CH ₃ OOH)	3.6 (5.1)	5.2 (7.3)
Methanol (CH ₃ OH)	2.4 (11.8)	2.7 (6.7)
Formic acid (HCOOH)	0.1 (1.2)	2.3 (9.7)
Peracetic acid (CH ₃ COOOH)	0.1 (0.8)	1.1 (2.7)
Acetic acid (CH ₃ COOH)	0.5 (1.5)	8.6 (16.3)
Other C ₃ -C ₅ isoprene and monoterpene oxidation products	0.7 (8.3)	8.1 (80.4)
Total (MtC yr ⁻¹)	10.8 (38.2)	39.1 (146.2)
Wet + dry deposition -(MtC yr ⁻¹)	49.9 (184.4)	

Table 4: Adjustments to the estimated change in the terrestrial biosphere (GtC yr⁻¹). The term $\Delta B_{incl.LUC} \Delta B_{act}$ refers to all **realisedactual** biospheric carbon-stock changes, including those due to LUC whereas $\Delta B \Delta B_{phys}$ excludes LUC effects and includes only physiological and age-class effects. The ‘inferred flux into the biosphere’ is calculated as the residual sink minus cement carbonation.

Original residual uptake	3.6
Cement carbonation	-0.2
Revised inferred flux into the biosphere	3.4
inland deposition	-0.6
river transport (DOC, POC)	-0.45
Flux of methane, NMVOC + intermediates	-0.05
Aeolian dust transport	-0.05
Harvested wood-products pool	-0.1
Change in landfill pool originating from harvested-wood products	-0.05
LUC	-1.3
$\Delta B_{incl.LUC} \Delta B_{act}$	0.8
$\Delta B \Delta B_{phys}$	2.1

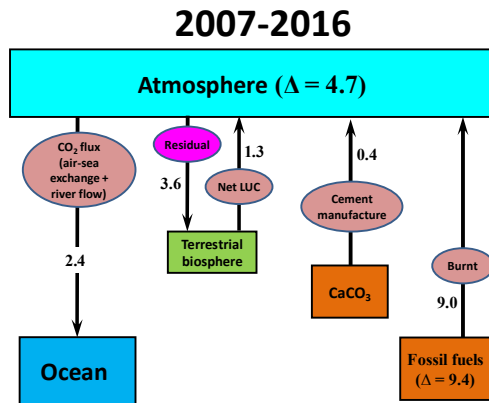
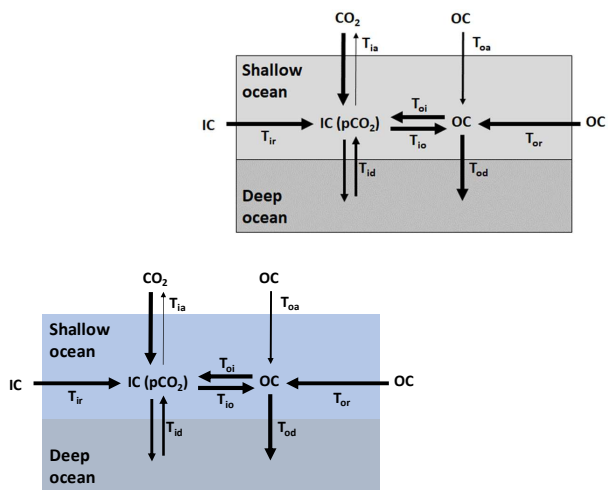
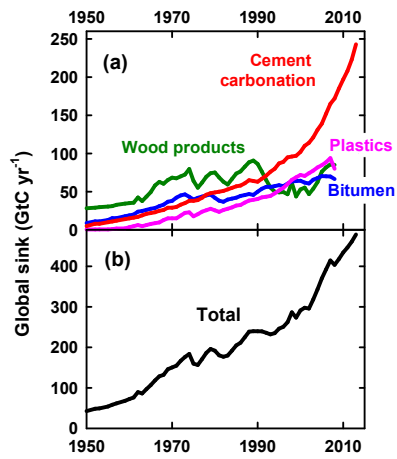

Figure 1: The main components of the global carbon cycle for the 2007–2016 period (after Le Querre et al., 2018). Annually, 9.4 GtC yr⁻¹ of fossil fuels were used of which 0.4 GtC yr⁻¹ were not oxidised but used for manufacturing secondary products, like plastics, or incompletely combusted so that only 9.0 GtC yr⁻¹ were released to the atmosphere. The ocean flux consists of estimated air-ocean CO₂ exchange plus river flux of inorganic CO₂.



5 Figure 2: Illustration of the key carbon fluxes from the atmosphere to the deep oceans, with subscripts 'i' and 'o' referring to inorganic and organic forms of carbon, respectively. T_{ia} and T_{oa} are exchanges with the atmosphere, T_{ir} and T_{or} are river transport, T_{io} and T_{oi} are the interconversions between organic and inorganic forms in the ocean, and T_{id} and T_{od} are the transfers from shallow to deep oceans.



5 Figure 3: Estimated net fluxes of carbon into the pools of harvested-wood products, plastics, bitumen and cement carbonation since 1950 (a) and their combined total (b). Redrawn from [Based on](#) data given in Lauk et al. (2012) and Xi et al. (2016).

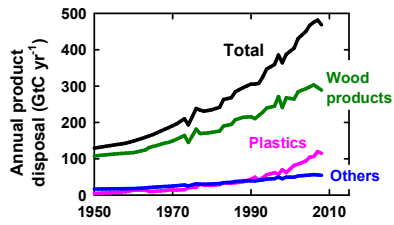

Figure 4: Annual rates of disposal of harvested-wood products, plastics and other carbon containing compounds. ~~Redrawn~~ **from** Based on data given in Lauk et al. (2012).

5

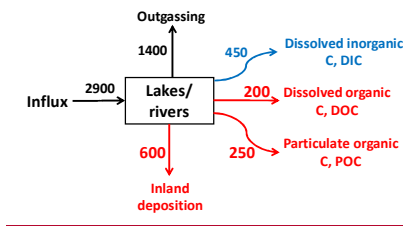
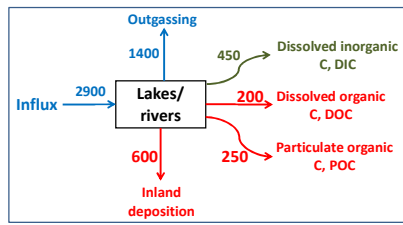

Figure 5: The main carbon fluxes in MtC yr^{-1} involving inland ~~water systems, waterways~~. The number shown in **greenblue** is already included in the global carbon budget, whereas the ~~numbernumbers~~ in red **are** should be added to the revised global carbon budget. The numbers in **blueblack** do not need to be included explicitly.

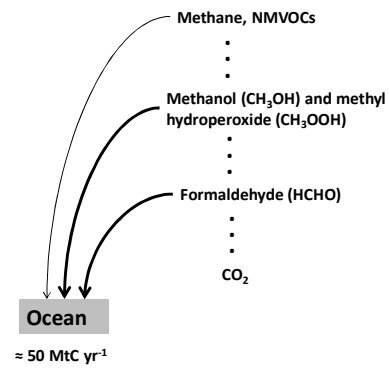

Figure 6: The main fluxes involved in the transfers of methane and NMVOCs to the oceans. Details of the estimated ~~overall~~ **fluxes** are given in Table 3.

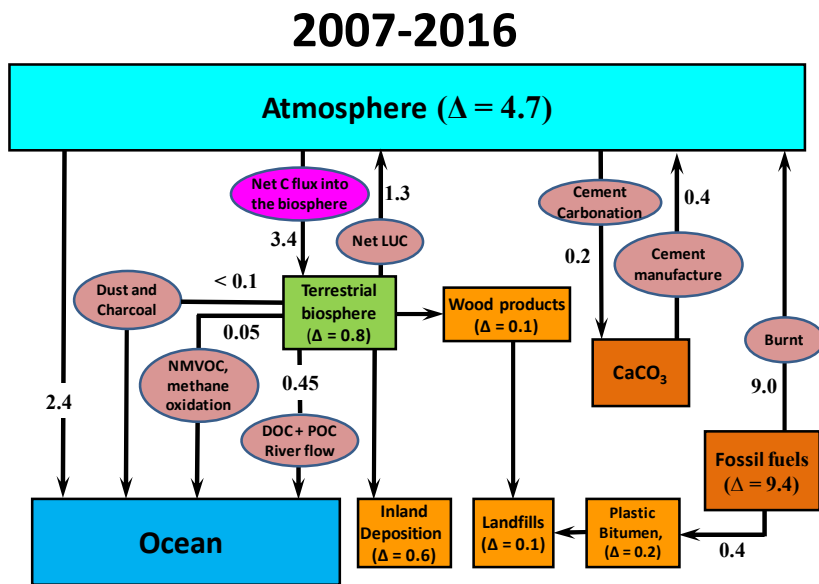
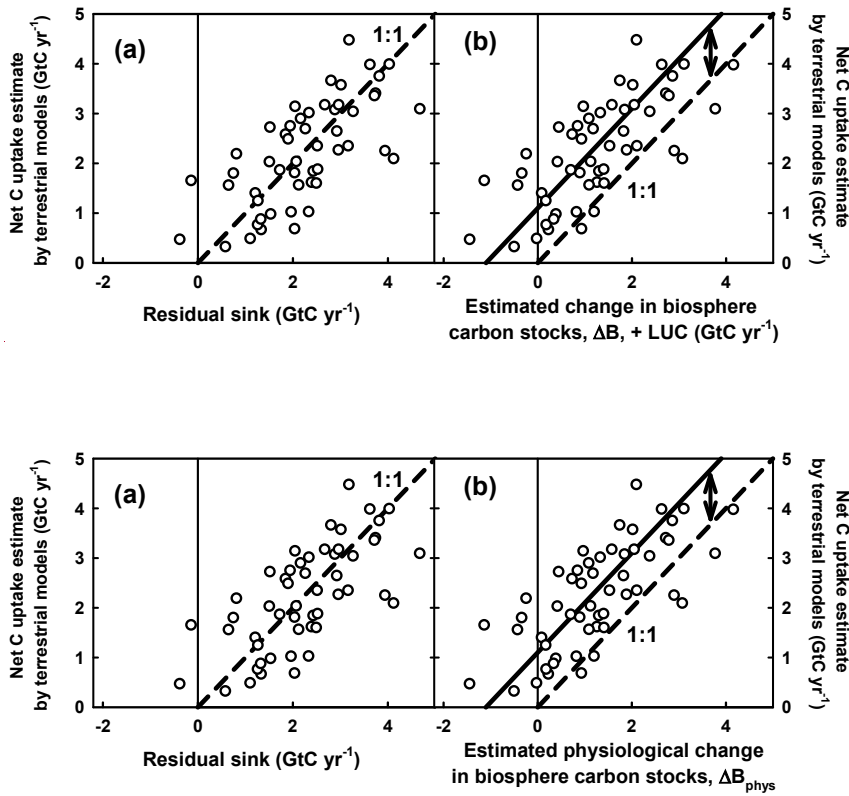

Figure 7: Expanded summary of the main components of the global carbon cycle for the 2007–2016 period. The fluxes are those given by Le Quere et al. (2018) as shown in Figure 1 above. These broad fluxes have then been modified based on Table 4 and the details provided in specific sections above. Rectangular boxes refer to identified important carbon storage pools in the global carbon budget. Fluxes described in ovals refer to key fluxes between these storage pools.



5 Figure 8: Mean estimates of net carbon uptake by the biosphere plotted against the residual sink (a), or as a function of the revised ΔB_{phys} calculated here (b). Data have been taken from Le Quere et al. (2018), with each point corresponding to an annual flux estimate since 1959. Data were calculated as given in Eq. 1. The dashed lines are 1:1 lines, and the solid line in (b) is off-set by 1.1 GtC yr⁻¹ but retains a slope of 1.